

mellerware®

makes life easier

MOHABI 1500W 7 Fin oil heater



complies with
INTERNATIONAL
IEC60335
SAFETY SPECIFICATIONS

m
1500W

2YEAR
WARRANTY

Model:
35150

2YEAR
WARRANTY
1YEAR RETAIL &
1YEAR EXTENDED



Register online: www.mellerware.co.za

Dear customer,

Thank you for choosing to purchase a Mellerware brand product. Thanks to its technology, design and operation and the fact that it exceeds the strictest quality standards, a fully satisfactory use and long product life can be assured.

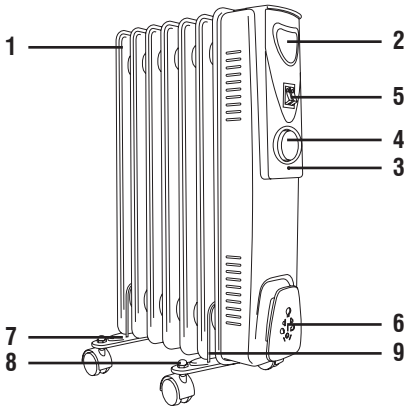

1. Parts description

1. Oil fins
2. Handle
3. Power indicator light
4. Adjustable thermostat control
5. Power/heat selection control
6. Cord storage bracket
7. Axle
8. Wing nut
9. "U" bracket

2. Safety advice and warnings!

Read these instructions carefully before switching on the appliance and keep them for future reference. Failure to follow and observe these instructions could lead to an accident. Clean all the parts of the product as indicated in the cleaning section, before use.

2.1. Use or working environment:

- 2.1.1. Keep the working area clean and well lit. Cluttered and dark areas invite accidents.
- 2.1.2. Use the appliance in a well ventilated area.
- 2.1.3. Do not place the appliance on hot surfaces, such as cooking plates, gas burners, ovens or similar items.
- 2.1.4. Keep children and bystanders away when using this appliance.

2.1.5. Place the appliance on a horizontal, flat, stable surface and away from other heat sources and contact with water.

2.1.6. Keep the appliance away from flammable material such as textiles, curtains, cardboard or paper, etc.

2.1.7. Do not place flammable material near the appliance.

2.1.8. Do not use the appliance in association with a programmer, timer or other device that automatically switches it on.

2.1.9. Do not use the appliance if the cable or plug is damaged.

2.1.10. Ensure that the voltage indicated on the rating label matches the mains power supply voltage before plugging in the appliance.

2.2.11. Connect the appliance to the mains power supply with an earth socket withstanding a minimum of 16 amperes.

2.1.12. The appliance's plug must fit into the mains power supply socket properly. Do not alter the plug.

2.1.13. If using a multi plug check ratings carefully as the current used by several appliances could easily exceed the rating of the multi plug.

2.1.14. If any of the appliance casings breaks, immediately disconnect the appliance from the mains power supply to prevent the possibility of an electric shock.

2.1.15. Do not use the appliance if it has fallen on the floor or if there are visible signs of damage.

2.1.16. Do not force the power cord. Never use the power cord to lift up, carry or unplug the appliance.

2.1.17. Do not wrap the power cord around the appliance.

2.1.18. Do not clip or crease the power cord.

2.1.19. Do not allow the power cord to hang or to come into contact with the hot surfaces of the appliance.

2.1.20. Check the state of the power cord. Damaged or tangled cables increase the risk of electric shock.

2.1.21. The appliance is not suitable for outdoor use.

2.1.22. Power cord should be regularly examined for signs of damage, and if the cord is damaged, the appliance must not be used.

2.1.23. Do not touch the plug with wet hands.

2.1.24. The oil fin heater should always be kept upright.

2.1.25. Its normal for the oil fin heater to make a noise while heating.

2.2. Personal safety:

2.2.1. CAUTION: Do not leave the appliance unattended during use as there is a risk of an accident.

2.2.2. This appliance is only for domestic use, not for industrial or professional use. It is not intended to be used by guests in hospitality environments such as bed and breakfast, hotels, motels, and other types of residential environments, even in farm houses, areas of the kitchen staff in shops, offices and other work environments.

2.2.3. This appliance is not intended for use by persons (including children) with reduced physical, sensory or mental capabilities, or lack of experience and knowledge, unless they have been given supervision or instruction concerning use of the appliance by a person responsible for their safety.

2.2.4. This appliance is not a toy. Children should be supervised to ensure that they do not play with the appliance.

2.3. Use and care:

2.3.1. Fully unroll the appliance's power cable before each use.

2.3.2. Do not use the appliance if the parts or accessories are not properly fitted.

2.3.3. Do not turn the appliance over while it is in use or connected to the mains power supply.

2.3.4. Unplug the appliance from the mains power supply when not in use and before undertaking any cleaning task.

2.3.5. This appliance should be stored out of reach of children.

2.3.6. Do not store the appliance if it is still hot.

2.3.7. Never leave the appliance unattended when in use and keep out of the reach of children.

2.3.8. If for some reason, the appliance were to catch fire, disconnect the appliance from the mains power supply and **DO NOT USE WATER TO PUT THE FIRE OUT.**

2.4. Service:

2.4.1. Make sure that the appliance is serviced only by suitably qualified technician, and that only original spare parts or accessories are used to

replace existing parts/accessories.

2.4.2. If the power cord is damaged, the manufacturer or its service agent or a similarly qualified person must replace it in order to avoid a hazard.

2.4.3. Any misuse or failure to follow the instructions for use renders the warranty and the manufacturer's liability null and void.

3. Instructions for use

3.1. Before use:

3.1.1. Remove the appliance's protective film (if applicable).

3.1.2. Before using the product for the first time, clean in the manner described in the cleaning section.

3.2. Assembly:

The heater is packaged with the feet unattached. You must attach them before operating the heater.

WARNING: Do not operate without feet attached. Operate the heater only in upright position (feet on the bottom, controls on the top), any other position could create a hazardous situation

1. Place the radiator body upside-down on a scratch-free location, make sure it is stable and will not fall.
2. Screw off the wing nuts from the U-shaped bolt provided, attach the U-shaped bolt to the U-facing flange between first and second fins (near the front cover).
3. To attach the castor mounting plate to the radiator body, you should insert the threaded ends of the U bolt in the holes on the castor mounting plate.
4. Screw the wing nuts back to the U bolt and fasten the wing nut properly.

Note: do not over tighten, which may cause the damage of radiator flange.

5. Screw off spherical nut from the castor, align the shaft to the hole of the castor mounting plate, insert in, and screw on the spherical nut.
6. Repeat 2, 3, 4 and 5 on the rear of radiator for mounting of the rear castors.

Note: the rear castors must be mounted between the end two fins.

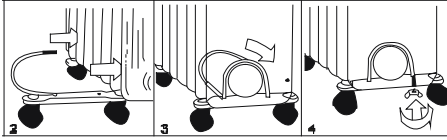

INSTRUCTIONS FOR USE

1. Before using the heater, make sure that it is on a flat and stable surface, damage may occur if it is placed on an incline or decline.

2. Set all the controls to OFF position and insert the plug into a socket-outlet with well grounded. Be sure that plug fits firmly.

3. Rotate the thermostat knob clockwise to MAX position and switch the heater on as follow: Switch the heater to the following power setting:

- a) Push switch one (MIN I)
- b) Push switch two (MAX II)
- C) Push switch one (MIN I) and (MAX II) heater setting together.

4. When your room reaches the desired temperature, now slowly rotate the thermostat knob counter clockwise until the pilot light goes out. The thermostat can now be left at this setting. As soon as the room temperature has dropped below the set temperature, the unit will switch itself on automatically until the set temperature has been reached again. In this way the room temperature remains constant with the most economical use of electricity.

5. If you want to change the room temperature setting, rotate the thermostat knob clockwise to raise the temperature, or counter clockwise to lower it.

6. This heater includes an overheat protection system that shuts off the heater when parts of the heater are getting excessively hot.

7. To completely shut the heater off, turn all the controls to OFF, and remove plug from the socket-outlet.

3.4. Once you have finished using the appliance:

3.4.1. Unplug the appliance from the mains power supply.

3.4.2. Allow the appliance to cool down completely.

3.4.3. Clean the appliance as described in the cleaning section.

4. Cleaning

4.1. Disconnect the appliance from the mains power supply and allow it to cool completely before undertaking any cleaning task.

4.2. Clean the outer parts of the appliance with a damp cloth with a few drops of washing-up liquid and then dry. CAUTION! Do not immerse electrical parts of the appliance in any liquid.

4.3. Do not use solvents, or products with an acid or base pH such as bleach, or abrasive products, for cleaning the appliance.

4.4. Never submerge the appliance in water or any other liquid or place it under running water.

5. Anomalies and repair

5.1. Take the appliance to an authorised support centre if product is damaged or other problems arise.

5.2. If the connection to the mains has been damaged, it must be replaced and you should proceed as you would in the case of damage.

Thank you for purchasing a Mellerware product. Mellerware guarantees that your product has been thoroughly inspected and tested before being dispatched and is free from mechanical and electrical defects and complies with the applicable safety standards. With every Mellerware product purchased you get a 2 year warranty as detailed in the terms and conditions below.

First Year – 1 Year Retail Warranty:

Should defects due to faulty parts or workmanship develop, under normal use, within 12 months from the original purchase date, please return the product to the store from where it was purchased for repair free of charge. However, for the customer's convenience we will replace products where the purchase price is equal to or less than R750 incl. VAT

Second Year – 1 Year Extended Warranty

Mellerware takes pride in their product quality and therefore offer an extended 12 month warranty over and above the 1 Year Retail Warranty. Should defects due to faulty material or workmanship develop, under normal domestic use, after the 12 month period and within 24 months from the original date of purchase, please return the product postage pre-paid to Mellerware for repair. Mellerware will repair the product free of charge and return it to you directly. Mellerware will replace a product with a similar product in the same or better condition, if the repair cannot be conducted for whatever reason.

NB: The 1 Year Extended Warranty is only valid for customers who have registered their warranty online at www.mellerware.co.za within the first year after making their purchase. See overleaf for details and instructions.

Before returning your product, check the following:

- Your household mains supply socket is in good condition, working and switched on.
- The mains supply circuit is not overloaded (White trip switch on your DB board is off).
- You have read the trouble shooting guide in your Instructions for Use.
- All accessories and parts are present.

The following conditions apply:

1. Please ensure you retain your original receipt as this must be presented when making a claim under the terms of the warranty. It is impossible to determine the warranty period without your original proof of purchase, so please keep this in a safe place. (NB. Your warranty can be scanned onto the Mellerware web site for safe storage – see reverse side for details.)
2. If a refund or exchange is required the product must be complete with all accessories, parts and packaging. Missing parts will render the warranty void.
3. Upon receipt of your appliance, check it for any transport damage to ensure it is safe for use. Return it to the store as soon as possible for exchange if damaged. The warranty is void if products are damaged after use, so please do not use the damaged product.
4. Your product is designed for normal domestic household use. Failure to read and comply with the

instructions for use, cleaning and maintenance will render your warranty void, so please read these instructions carefully to ensure your safety, and to get the most effective use from the product. (e.g. not removing lime scale; water deposits; insect infestation, and/or burnt products)

5. Any abuse, negligent, improper or accidental use or care will render the warranty void and Creative Housewares (Pty) Ltd will not be liable for any loss or damage.
6. Any attempted repair, or replacement of unauthorised parts will render the warranty void, so please contact an authorised service centre or service agent for any service or repair requirements.
7. NB: The warranty on replaced products will be from the original date of purchase and not from when the date replacement was made.
8. All repairs carry a 3 month warranty even if this falls outside of the 2 year warranty period.
9. Mellerware will attempt to conduct repairs within reasonable time in line with industry standards but cannot be held responsible or liable for any circumstances not under our control.
10. Terms and Conditions are subject to change without prior notice.

Repairs Out of the Warranty Period

If service or repair becomes necessary outside the warranty period, this service is still available however all transport/postage, spares and labour costs will be for the customers' account. All chargeable repairs will require the customers' written acceptance of the quote. Once the go-ahead has been received Mellerware will undertake to conduct the repair within a reasonable time and maintain the condition of the product as received. All repairs are warranted for 3 months from the date of the repair.

For any service, enquiries and complaints please contact our Customer Care on 086 111 5006 or e-mail help@chwsa.co.za from 08h00 to 15h00 Monday to Friday excluding public holidays. Please also note that the company is normally closed for 2 weeks around Christmas and New Year.

Please send all products for repair postage pre-paid to one of the service centres listed on the back of this page.

ONLINE WARRANTY REGISTRATION

Why register your warranty?

We at Mellerware pride ourselves on bringing premium quality appliances to market, and as a commitment to this level of quality we offer a 2 year warranty (1 Year Retail + 1 Year Extended) on all of our products. We often hear that our customers lose their receipts and can therefore no longer claim if they have a problem. To take advantage of the 1 Year Extended Warranty you will need to register your warranty online within the first year of purchase in order to make a valid claim. Now you can register your product, upload your warranty online, never have to worry about losing your receipt again and enjoy the benefit of your 2 year warranty.

Added Benefits

In addition to providing you with an online profile of your registered products we will also provide a host of value added benefits:

- Incentives and Competitions for registered users
- New recipes or ideas for your products
- New product developments – be the first to get the latest appliances
- Special offers on promotional items

How to Register your Online Warranty?

STEP1 Create your user profile:

If you haven't done so already, simply visit www.mellerware.co.za, click on the "Product Registration" link and follow the easy instructions. You will receive a user-name and password once registered. This will give you access to your user profile.



STEP2 Pick a registration method:



DESKTOP/ LAPTOP

- Open your internet browser and visit www.mellerware.co.za
- Click on the "Registration" link and login using your user name and password.
- Click on "Register your products and upload receipts" and follow the easy instructions.
- Scan and upload your receipt



SMART PHONE/ TABLET

- Scan the QR code above or visit www.mellerware.co.za
- Click on the "Registration" link and login using your user name and password.
- Click on "Register your products and upload receipts" and follow the easy instructions.
- Scan or take a photo and upload your receipt.



FAX

- Fax the following to 021 931 4058
- First Name and Surname
- Contact telephone and fax number.
- Product Model number and Type.
- Traceability Code (found on a label on the product)
- A clear and legible copy of your receipt.

Notes:

1. The online warranty system is a safe storage facility for your receipt.
2. You will be required to register on the Mellerware website. You will receive a username and password once registered. This will give you access to your profile.
3. From your profile you will be able to load products that you have purchased. In order to successfully register your warranty you will need to either scan and upload, or fax through your receipt to us.
4. All instructions on how to load your products are available

inside your profile.

5. Please note that you must check that your receipt has been uploaded correctly. Creative Housewares cannot be held responsible for faxes or files not received.
6. For assistance with registration please email: marketing@chwsa.co.za

NB: Your 1 year extended warranty is only valid if your product is registered online within the first year after purchasing your Mellerware product. Failure to register your product on-line within the first year will render the extended warranty as void.

creative housewares

National Service Centre: 086 111 5006

e-mail: help@chwsa.co.za

www.creativehousewares.co.za

Cape Town

120 Tekstiel Street, Parow, Cape Town, 7493,
South Africa • P.O. Box 6156 Parow East, 7501,
South Africa Tel: +27 21 931 8117
Fax: +27 21 931 4058

Durban

35 Adrain Road, Windermerse,
Durban, South Africa, 4001
Tel: +27 31 303 3465
Fax: +27 31 303 8259

Johannesburg

Unit 25 & 26 San Croy Office Park
Die Agora Road, Croydon, 1619
Tel: +27 11 392 5652
Fax: +27 11 392 1694

Dankie vir die aankoop van 'n Mellerware produk. Mellerware waarborg dat u produk deeglik geïnspekteer en getoets word voordat dit versend word en is vry van meganiese en elektriese gebreke en voldoen aan die toepaslike veiligheidsstandaarde. Met elke Mellerware produk wat gekoop word kry u 'n 2 jaar waarborg soos uiteengesit in die terme en voorwaardes hieronder.

Eerste Jaar - 1 Jaar Kleinhandelswaarborg:

Indien defekte as gevolg van foutiewe onderdele of vakmanskap binne 12 maande onder normale huishoudelike gebruik ontwikkel, binne die 12 maande vanaf die oorspronklike datum van aankoop, neem asseblief die produk na die winkel van waar dit gekoop is vir 'n terugbetaling of vervanging.

Tweede Jaar - 1 Jaar Uitgebreide Waarborg

Mellerware is trots op die kwaliteit van die produk en bied dus 'n uitgebreide 12 maande waarborg bo en behalwe die 1 Jaar kleinhandelswaarborg. Indien defekte as gevolg van foutiewe materiaal of vakmanskap ontwikkel, onder normale huishoudelike gebruik, na die 12 maande tydperk en binne 24 maande vanaf die oorspronklike datum van aankoop, stuur die produk terug met posgeld betaal na Mellerware vir herstel. Mellerware sal die produk gratis herstel en dit direk aan u terugstuur. Mellerware sal die produk vervang met 'n soortgelyke produk in dieselfde of beter toestand, as die herstel nie uitgevoer kan word vir watter rede ookal nie.

NB: Die 1 Jaar Uitgebreide waarborg is slegs geldig vir kliënte wat hul waarborg geregistreer het op ons webtuiste by www.mellerware.co.za binne die eerste jaar nadat hulle dit aangekoop het. Sien keersy vir besonderhede en instruksies.

Voordat u die produk terug stuur, maak seker van die volgende:

- U huishoudelike geleidingsok is in 'n goeie toestand, werk en aangeskakel is,
- Die geleidingsok is nie oorlaai nie (Wit uitskop skakelaar op u DB bord af is),
- U het die moeilikheid steuringsgids gelees in u instruksies vir gebruik,
- Alle bykomstighede en dele teenwoordig is.

Die volgende voorwaardes geld:

1. Maak seker dat jou oorspronklike kwitansie behoue is, dit moet aangebied word wanneer 'n eis gemaak word onder die voorwaardes van die waarborg. Dit is onmoontlik om die waarborg tydperk te bepaal sonder die bewys van aankoop, so hou dit asseblief in 'n veilige plek. (NB. Jou oorspronklike waarborg kan opgeskander word na die Mellerware webtuiste vir veilige bewaring - sien keersy vir meer inligting.)
2. Indien 'n terugbetaling of omruiling van die produk nodig is moet die produk volledig wees met al die bykomstighede, onderdele en verpakking. Toebehoore wat weg is sal die waarborg nietig maak.
3. Met ontvangs van u toestel, gaan dit na vir enige vervoer skade om te verseker dat dit veilig is vir gebruik. Stuur dit

so gou as moontlik terug na die winkel om die beskadigde toestel te vervang. Die waarborg is nietig indien die beskadigde produk gebruik word na die tyd, so moet asseblief nie die beskadigde produk gebruik nie.

4. U produk is ontwerp vir normale huishoudelike gebruik. Deur te versuim om die instruksies te lees en te voldoen aan die terme van gebruik, die skoonmaak en instandhouding van die produk maak u waarborg ongeldig, so lees asseblief hierdie instruksies versigtig om u veiligheid te verseker, en om die beste uit die gebruik van die produk te kry. (bv nie die verwydering van kalk skaal; water neerslag; insek besmetting, en / of verbrande produkte)
5. Enige misbruik, nalatige, onbehoorlike of toevallige beskadiging of sorg van die produk word die waarborg nietig en Creative Housewares (Pty) Ltd, sal nie aanspreeklik wees vir enige verlies of skade nie.
6. Enige poging tot herstel, of vervanging met ongemagtigde onderdele sal die waarborg nietig maak, so kontak 'n gemagtigde dienssentrum of diensagent vir enige diens of herstelwerk.
7. NB: Die waarborg op die vervangingsprodukt sal by die oorspronklike datum van aankoop bly en nie van die datum wanneer dit vervang is nie.
8. Alle herstelwerk dra 'n 3 maande waarborg selfs al val dit buite die 2-jaar waarborg tydperk.
9. Mellerware sal probeer om die herstelwerk te doen binne 'n redelike tyd in lyn met die industrie standaarde, maar kan nie verantwoordelik gehou word of aanspreeklik wees vir enige omstandighede nie onder ons beheer nie.

Herstelwerk buite die waarborg tydperk

As diens of herstelwerk benodig word buite die waarborg tydperk, is hierdie diens steeds beskikbaar, maar is alle vervoer / posgeld, onderdele en arbeidskoste op die kliënte se onkoste. Alle betaalbare herstelwerk sal skriftelike aanvaarding van die kwotasie vereis van die kliënt. Sodra Mellerware die groen lig ontvang sal ons onderneem om die herstel binne 'n redelike tyd en in dieselfde toestand te hou as wat die produk ontvang is. Alle herstelwerk is gewaarborg vir 3 maande vanaf die datum van die herstel.

Vir enige diens, navrae en klagtes kontak ons kliënte diens op 086 111 5006 of e-pos help@chwsa.co.za vanaf 08h00 tot 15h00, Maandag tot Vrydag, openbare vakansiedae uitgesluit. Let asseblief ook daarop dat die maatskappy gewoonlik gesluit is vir 2 weke gedurende Kersfees en Nuwejaar.

Stuur asseblief alle produkte vir herstel met posgeld vooruit betaal aan een van die diensentrums wat op die agterkant van hierdie bladsy verskyn.

AANLYN WAARBORG REGISTRASIE

Hoekom moet u die waarborg moet registreer?

Ons by Mellerware is trots om premium gehalte toestelle op die mark te bring, en as 'n verbintenis tot die vlak van gehalte bied ons 'n 2 jaar waarborg (1 Jaar Kleinhandel + 1 Jaar Uitgebreide) op al ons produkte. Ons hoor dikwels dat ons kliënte hul kwitansies verloor en kan dus nie meer eis as hulle 'n probleem het nie. Om voordeel te trek van die 1 Jaar Uitgebreide waarborg sal u nodig hê om u waarborg aanlyn te registreer binne die eerste jaar van aankoop om 'n geldige eis te maak. Nou kan u die produk aanlyn registreer, laai u waarborg en hoef u nooit te bekommer dat u die kwitansie sal verloor nie en die voordeel van u 2-jaar waarborg geniet.

Bygevoegde Voordele

Bykomend tot die verskaffing van 'n aanlyn profiel van u geregistreerde produkte bied ons ook vele ander toegevoegde waarde voordele:

- aansporings en kompetisies vir geregistreerde gebruikers
- nuwe resepte of idees vir u produkte
- nuwe produk ontwikkelings - die eerste wees om die nuutste toestelle te kry
- spesiale aanbiedings op promosie-items

Hoe om u Aanlyn Waarborg te Registreer?

STAP 1 Skep u gebruikersprofiel:

As u dit nie reeds gedoen het nie, besoek www.mellerware.co.za, klik op die "Product Registration" skakel en volg die maklike instruksies. U sal 'n gebruikersnaam en wagwoord ontvang sodra u geregistreer het. Dit sal u toegang tot u profiel gee.



STAP 2 Kies 'n registrasie metode:



REKENAAR/ SKOOTREK- ENAAR

- Maak u internet snuffelgids oop en besoek www.mellerware.co.za
- Klik op die "Registrasie" skakel en teken in met u gebruikersnaam en wagwoord.
- Klik op "Register your products" en laai kwitansies en volg die maklike instruksies.
- Skandeer en laai u strokie



SMART- FOON / TABLET

- Skandeer die QR-kode bo of besoek www.mellerware.co.za
- Klik op die "Registration" skakel en teken aan met u verbruikersnaam en wagwoord.
- Klik op "Register your products" en laai u kwitansie en volg die maklike instruksies.
- Skandeer of neem 'n foto en laai u strokie.



FAKS

- Faks die volgende na 021 931 4058
- Naam en Van
- Kontak telefoon en faksnommer.
- Produk model nommer en tipe.
- Traceability Code (wat op die Waarborgkaart of op 'n etiket op die produk gevind kan word)
- 'n Duidelike en leesbare afskrif van u ontvangs.

Notas:

1. Die aanlyn waarborg stelsel is 'n veilige stoor fasiliteit vir u strokies.
2. U sal gevra word om op die Mellerware webtuiste te registreer. U sal 'n gebruikersnaam en wagwoord ontvang. Dit sal u toegang gee tot u profiel.
3. Van u profiel u sal in staat wees om produkte te laai wat u gekoop het. Om u waarborg suksesvol te registreer sal u nodig hê om of te skandeer en oplaai, of faks u strokie deur na ons.
4. Alle instruksies oor hoe om u produkte te laai is beskikbaar binne in u profiel.
5. Let daarop dat u moet seker maak dat u kwitansie korrek op-

gelaai is. Creative Housewares kan nie verantwoordelik gehou word vir fakske of lêers nie ontvang nie.

6. Vir hulp met registrasie e-pos asseblief: marketing@chwsa.co.za

NB: U 1 jaar verlengde waarborg is slegs geldig indien u produk aanlyn geregistreer is binne die eerste jaar na die aankoop van u Mellerware produk. Indien u produk nie aanlyn geregistreer word binne die eerste jaar nie sal dit die verlengde waarborg nietig maak.

creative housewares

National Service Centre: 086 111 5006

e-mail: help@chwsa.co.za www.creativehousewares.co.za

Cape Town

20 Tekstiel Street, Parow, Cape Town, 7493,
South Africa • P.O. Box 6156 Parow East, 7501,
South Africa Tel: +27 21 931 8117
Fax: +27 21 931 4058

Durban

35 Adrian Road, Windermere,
Durban, South Africa, 4001
Tel: +27 31 303 3465
Fax: +27 31 303 8259

Johannesburg

Unit 25 & 26 San Croy Office park
Die Agora Road, Croydon, 1619
Tel: +27 11 392 5652
Fax: +27 11 392 1694

Durban
35 Adrain Road, Windermere,
Durban, South Africa, 4001
Tell: +27 31 303 3465
Fax: +27 31 303 8259

creative housewares
🏠 20 Tekstiel St, Parow. cape Town. 7493, RSA
✉ P.O. Box 6156 Parow East, 7501, RSA
☎ +27 21 931 8117 / Helpline: 086 111 5006
📞 +27 63 014 0457 📠 +27 21 931 4058
🌐 www.creativehousewares.co.za

Johannesburg
Unit 25 & 26 San Croy Office Park
Die Agora Road, Croydon, 1619
Tell: +27 11 392 5652
Fax: +27 11 392 1694

